

THANK YOU!

Thank you for your downloading this product!
I hope you love this resource as much as we do.

Please contact me if you have any questions at all
michala@keepingmykiddobusy.com

I am always happy to help.

Let's be friends! Click any of the buttons below.



TERMS OF USE

♥ All pages in this resource are © Keeping My Kiddo Busy, LLC 2022

♥ This license is for individual use only. If you wish to share with another teacher, please direct them to my [store](#). If an entire school or district intends to use this resource, please purchase the appropriate license.

♥ It is strictly forbidden by the DMCA to sell or share this resource on any website. If you are a teacher, you may upload and share this resource with your students on your password protected virtual classroom.



TpT Keeping My Kinders Busy
keepingmykiddobusy.com



Away with the Pixels

Graphics and font thanks to:
Hidsey's Clip Art



Let's learn the **ALPHABET**

Thank you for downloading this freebie!

I hope you love this resource as much as we do.

This product is intended for individual or single classroom use only.
Please do NOT file share or upload any part of this resource to the web.

All materials are
© 2022 Keeping My Kiddo Busy, LLC
All rights reserved keepingmykiddobusy.com



LOVE THIS FREEBIE?

CLICK HERE

to purchase the entire resource!



SAVE WITH THE BUNDLE

CLICK HERE

to purchase the complete alphabet bundle

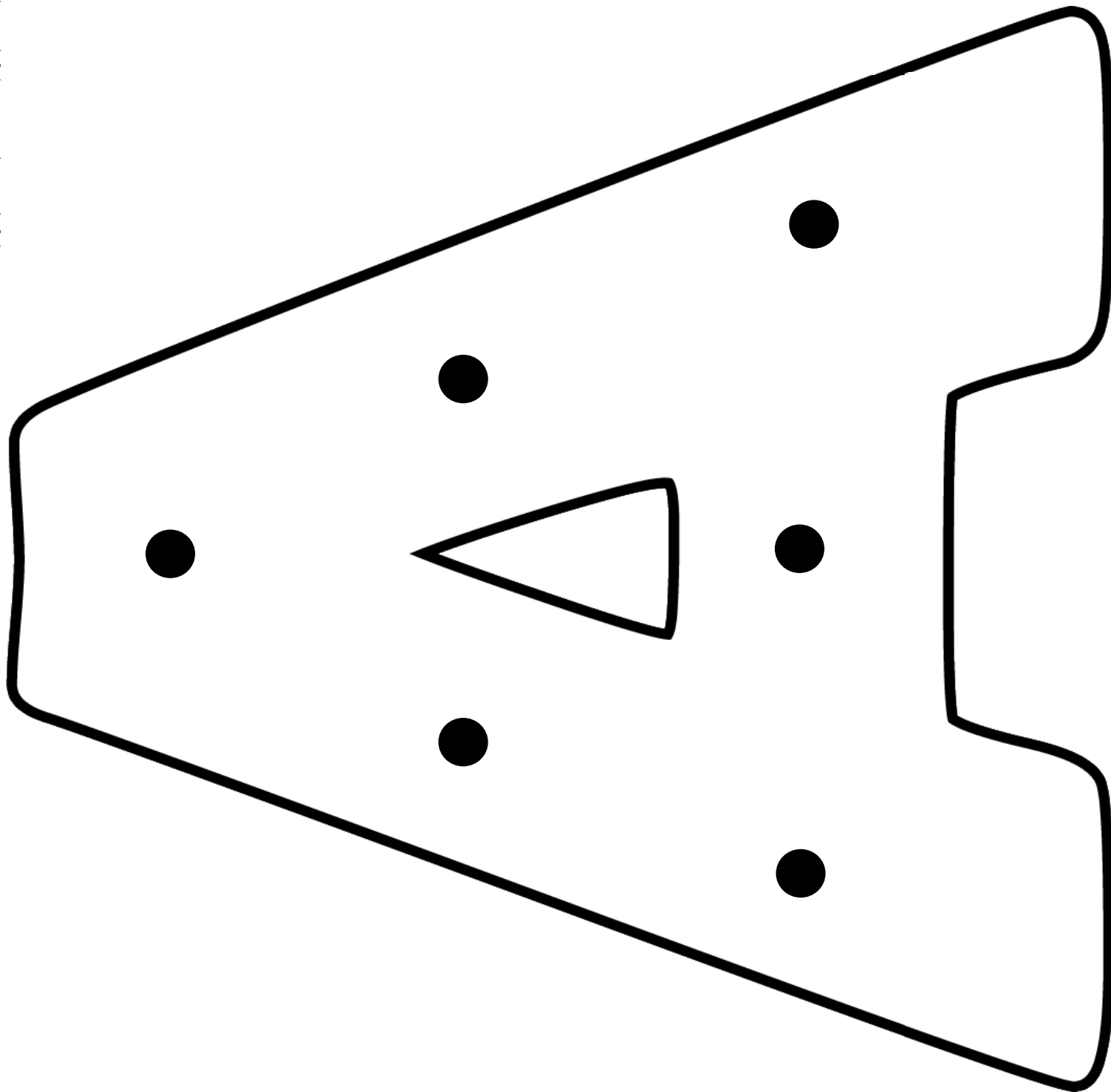
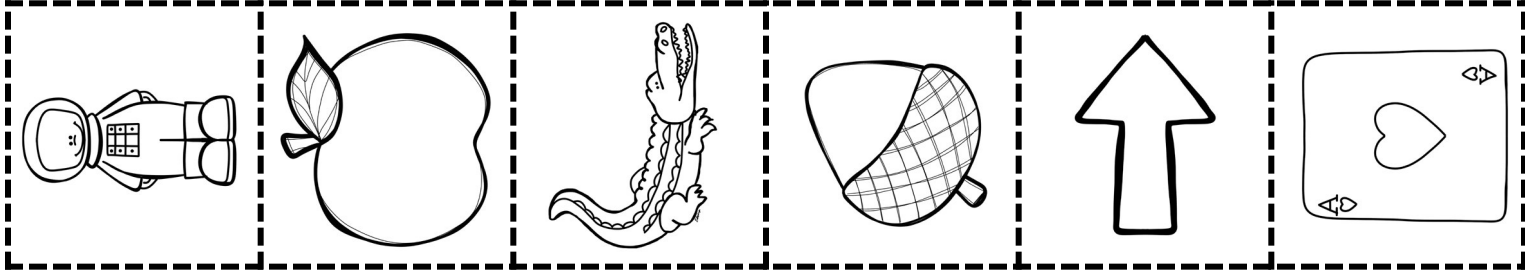

Name _____

Date _____

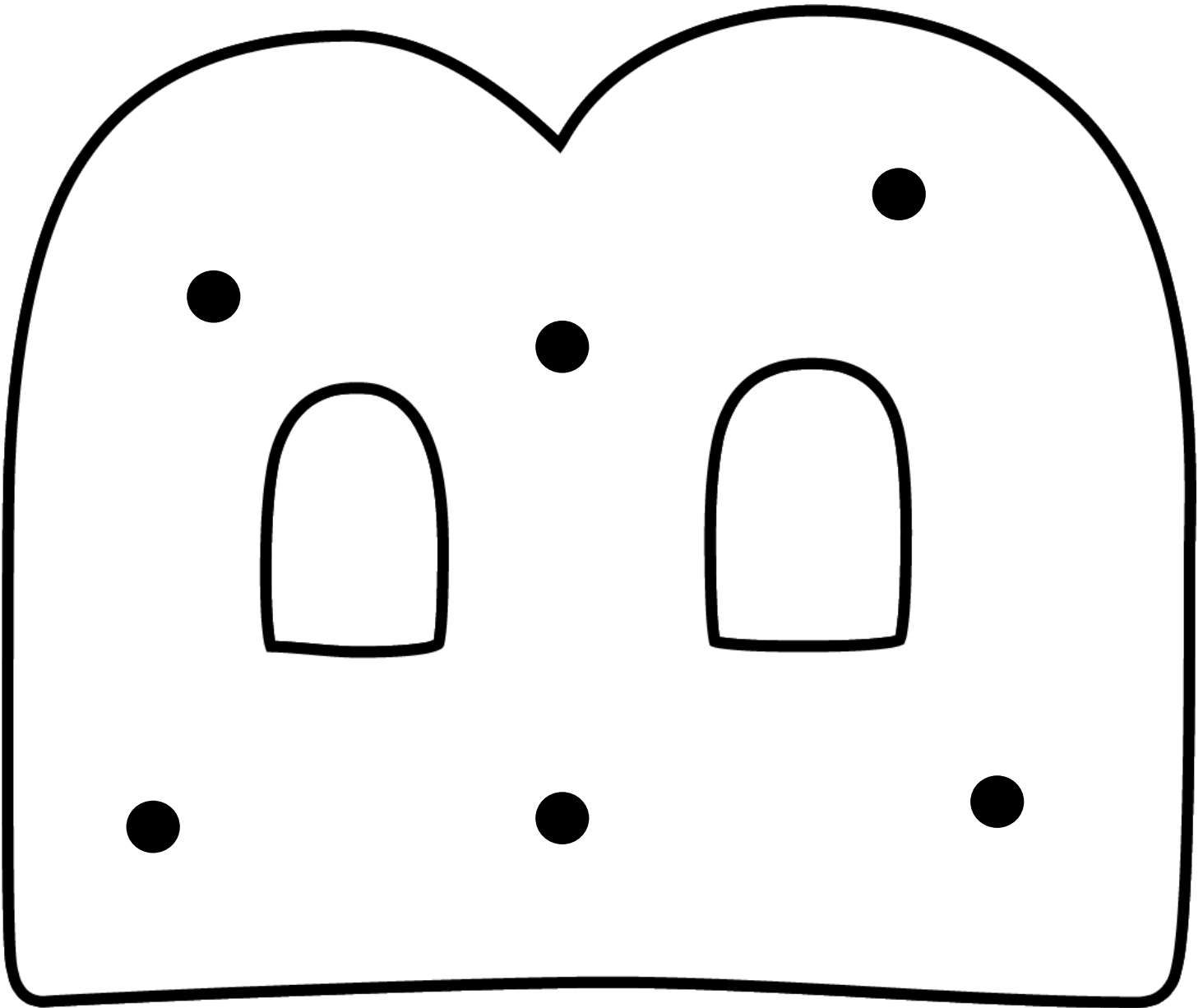
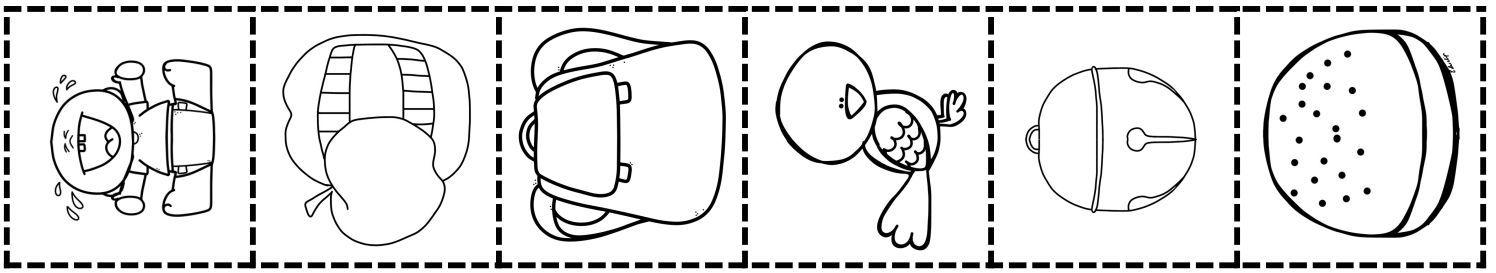

Name _____ Date _____

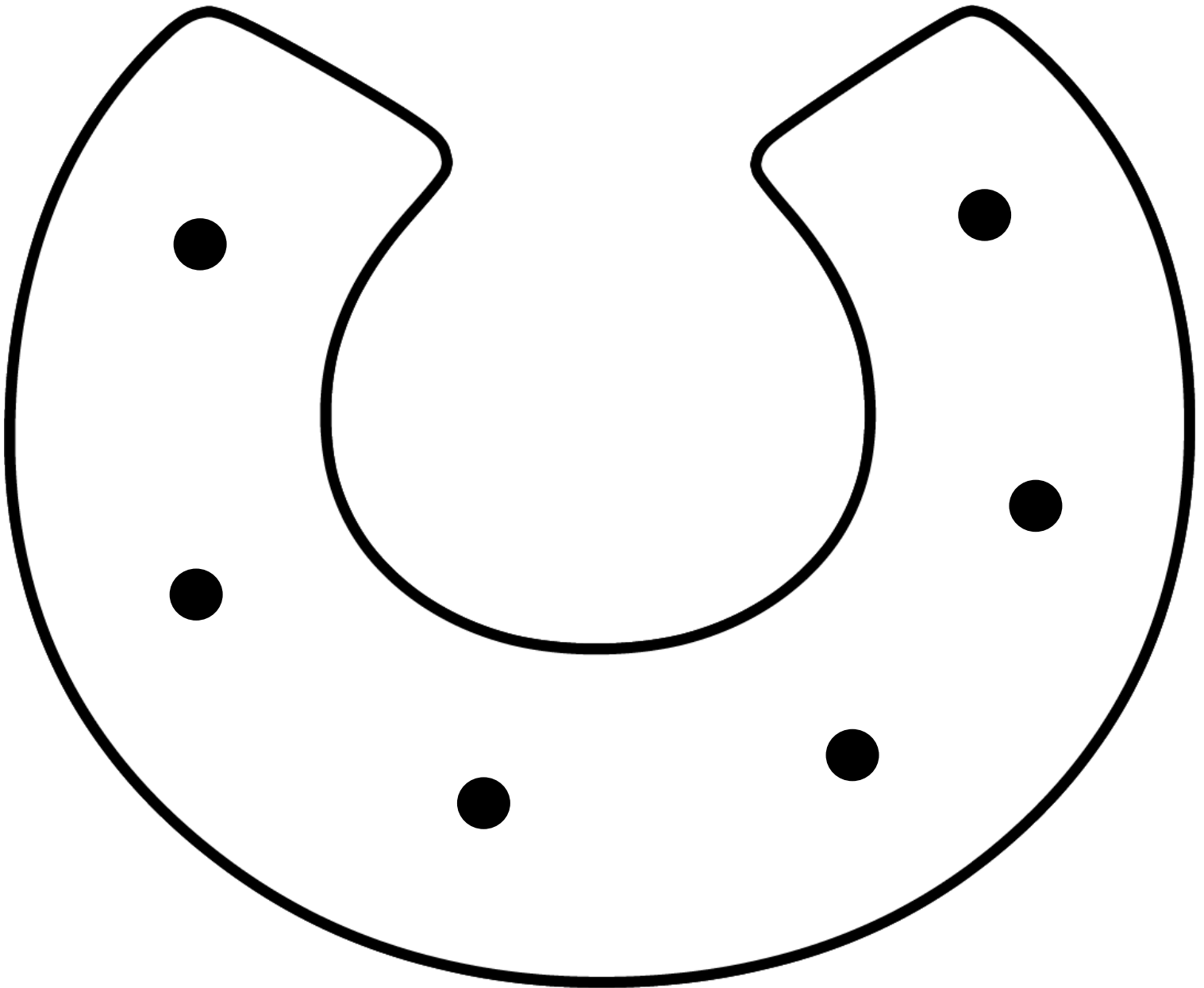
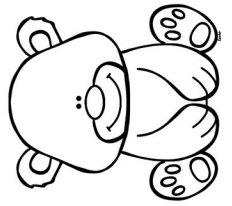
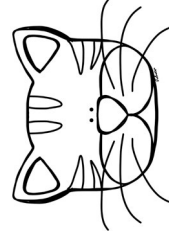
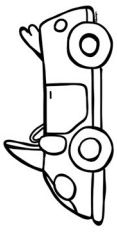

Name _____

Date _____

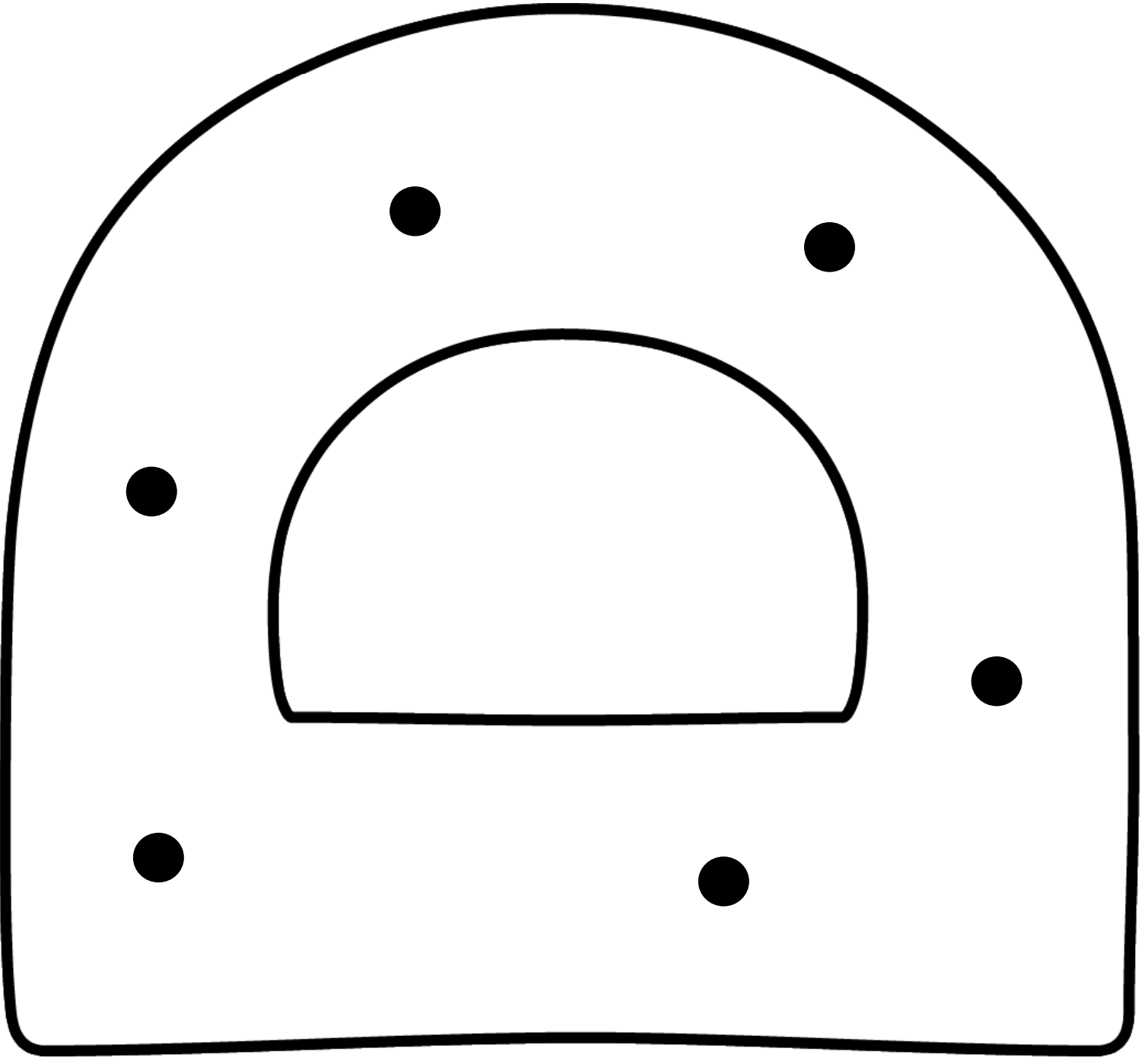
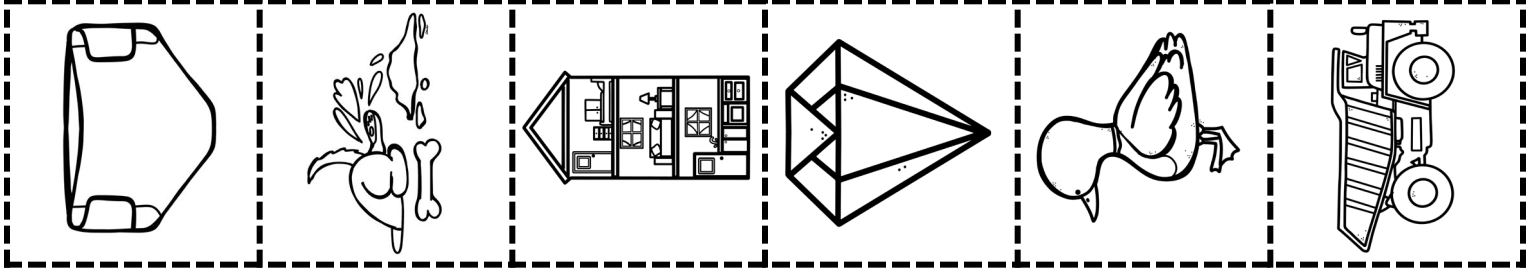

Name _____

Date _____

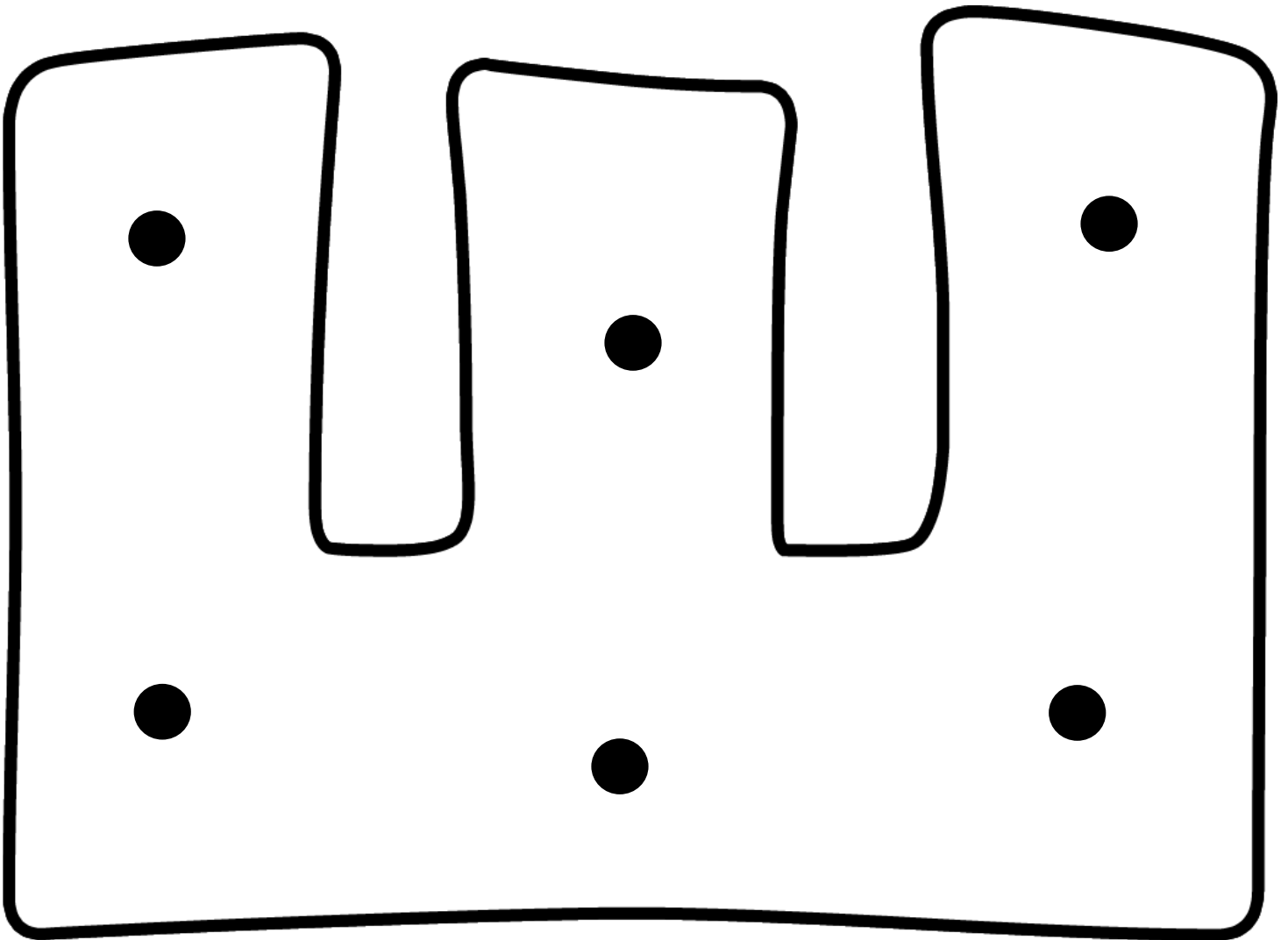
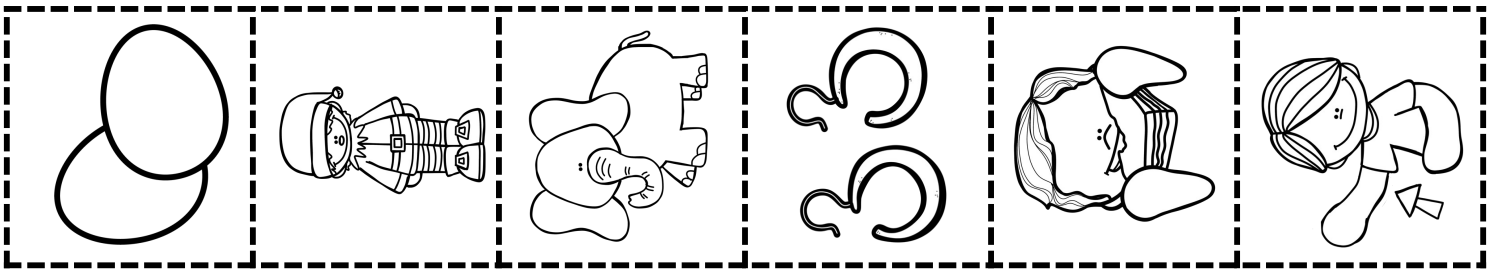

Name _____ Date _____

Cut out and glue
the pictures
that
match the
letter.

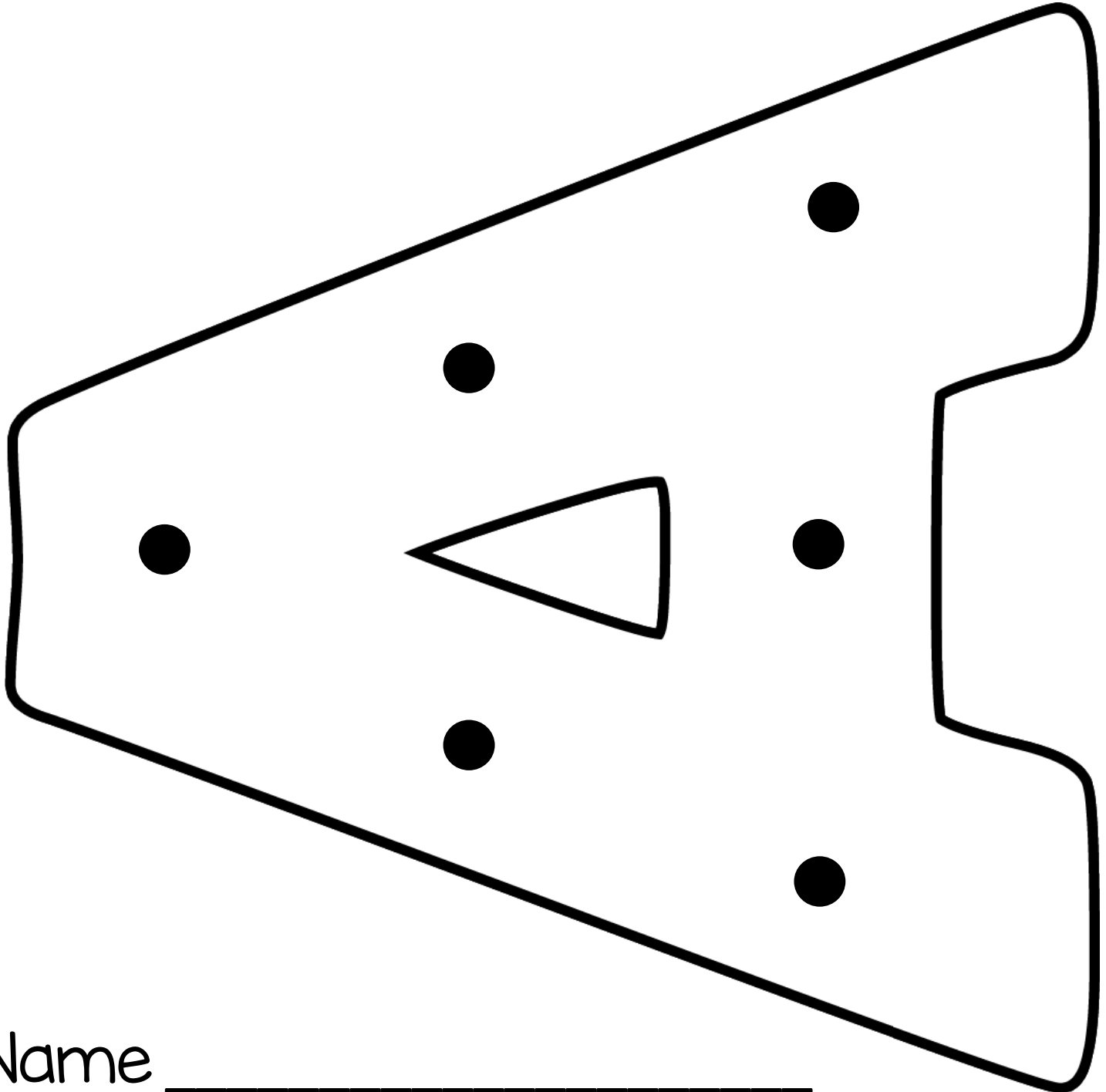
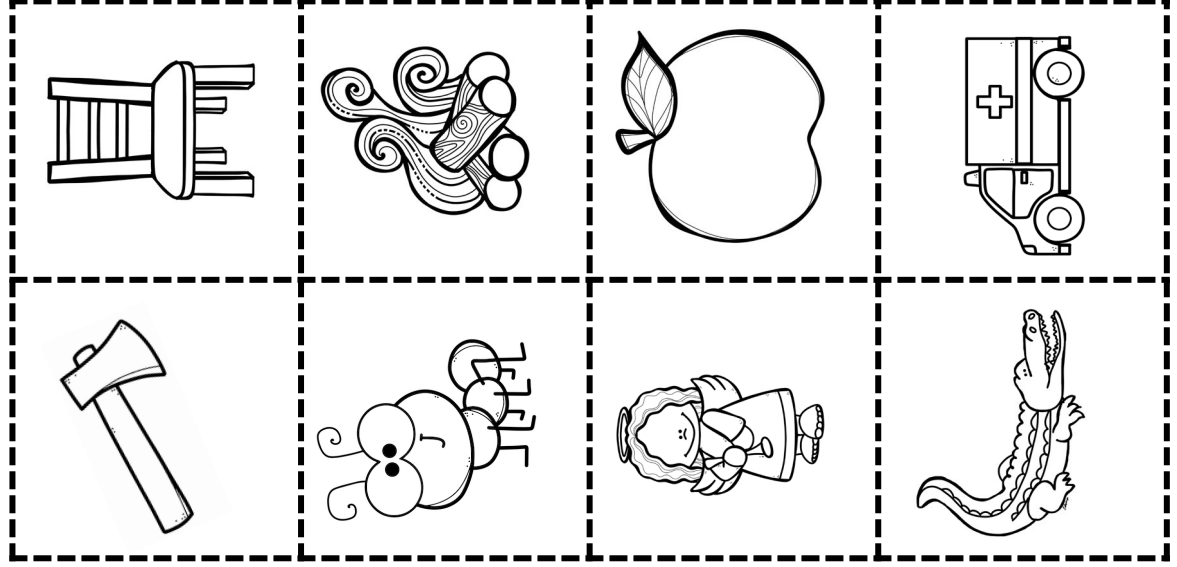

Name _____

Cut out and glue
the pictures
that
match the
letter.

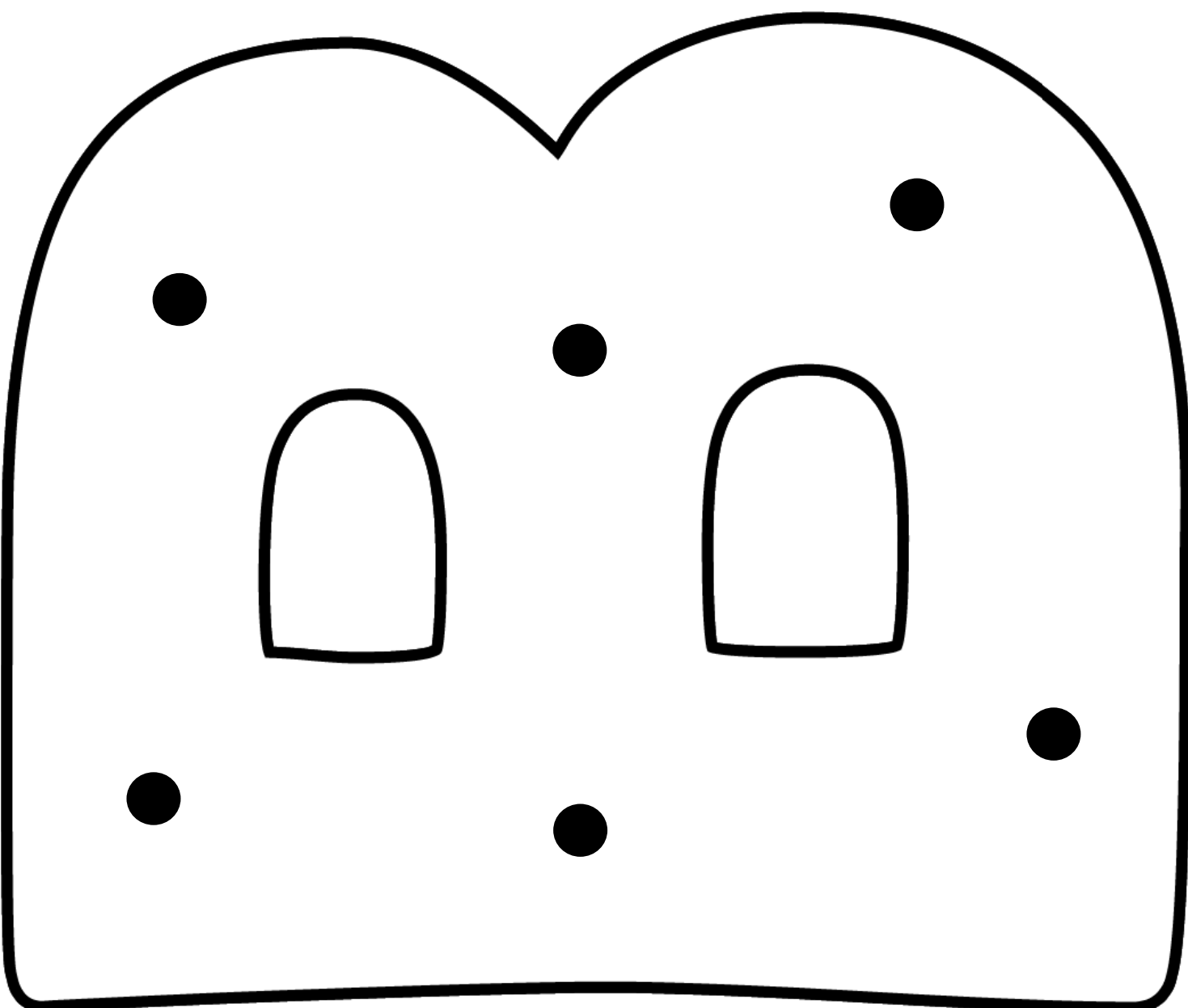
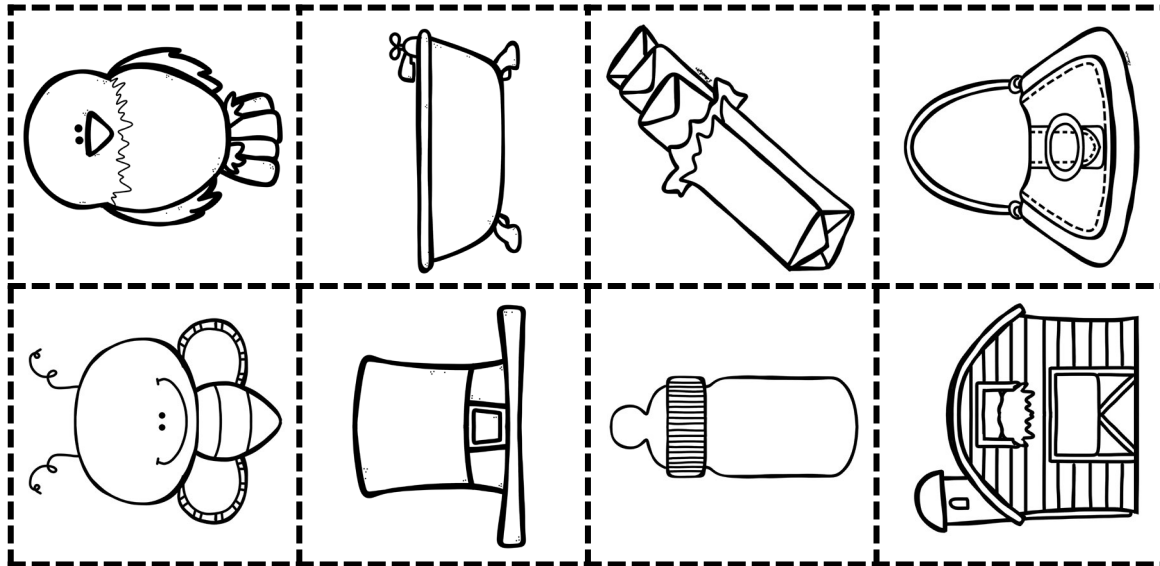

Name _____

Cut out and glue
the pictures
that
match the
letter.

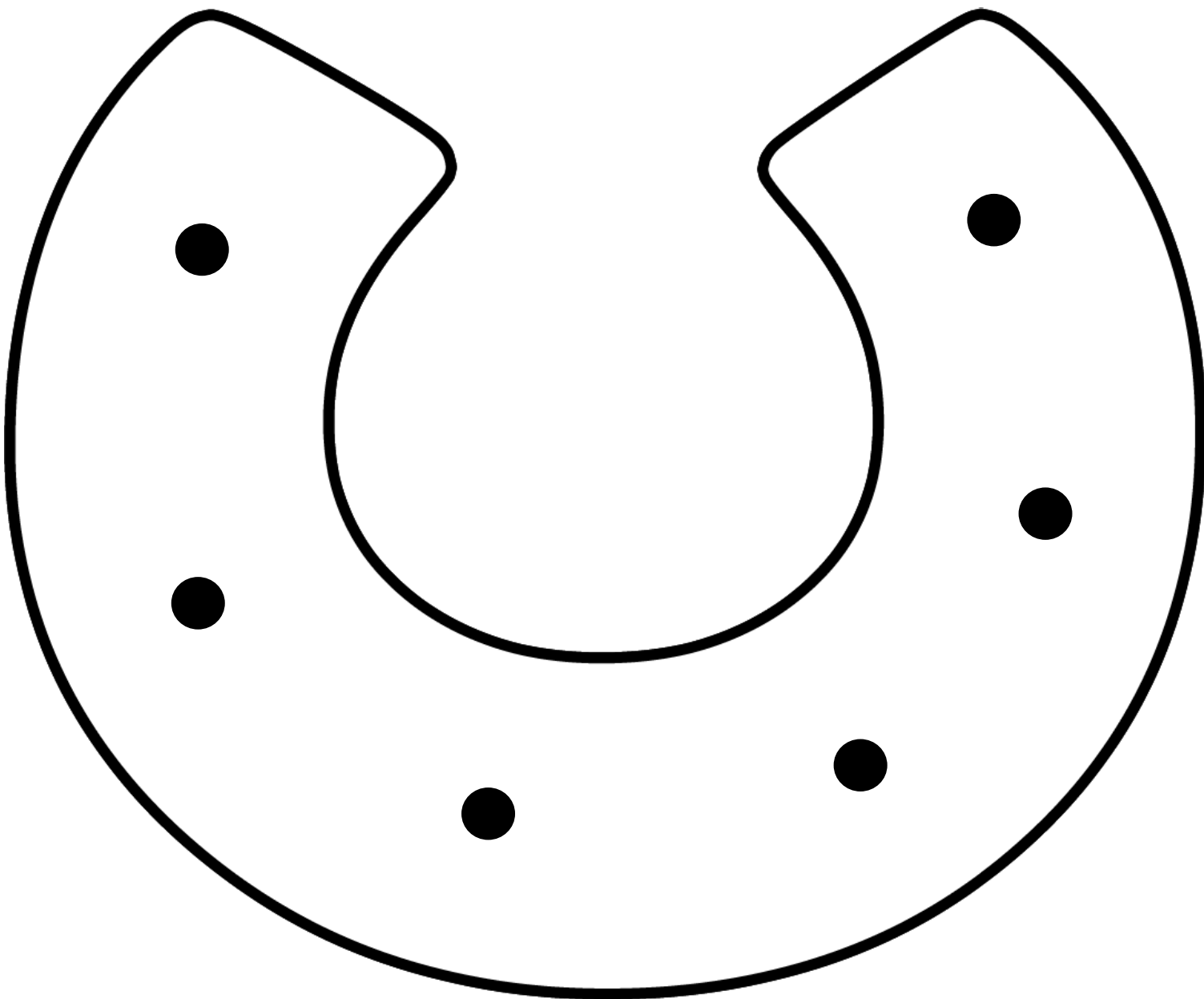
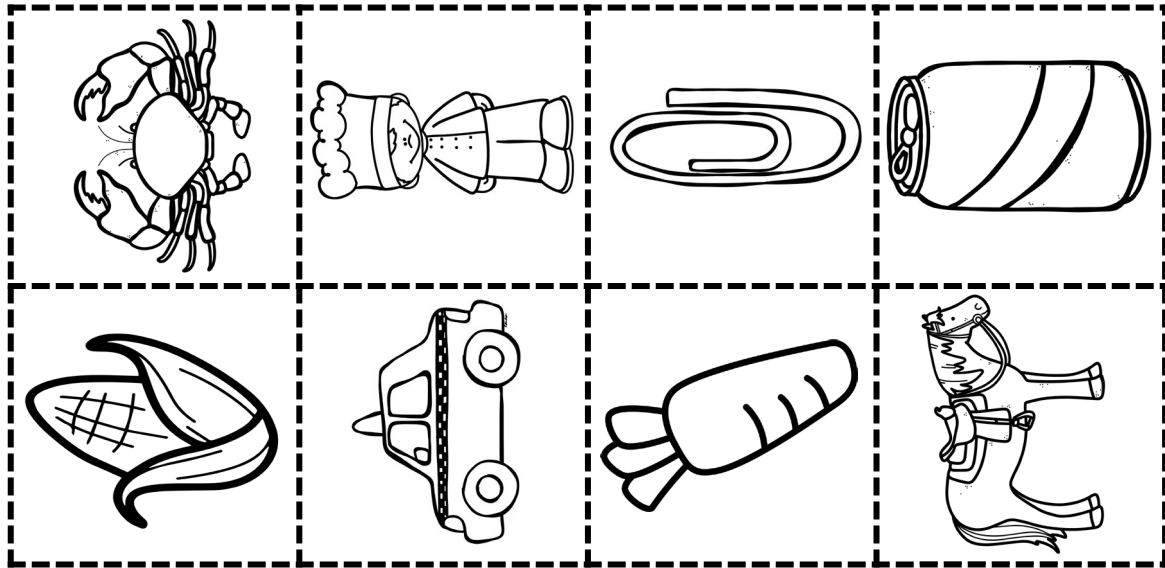

Name _____

Cut out and glue
the pictures
that
match the
letter.

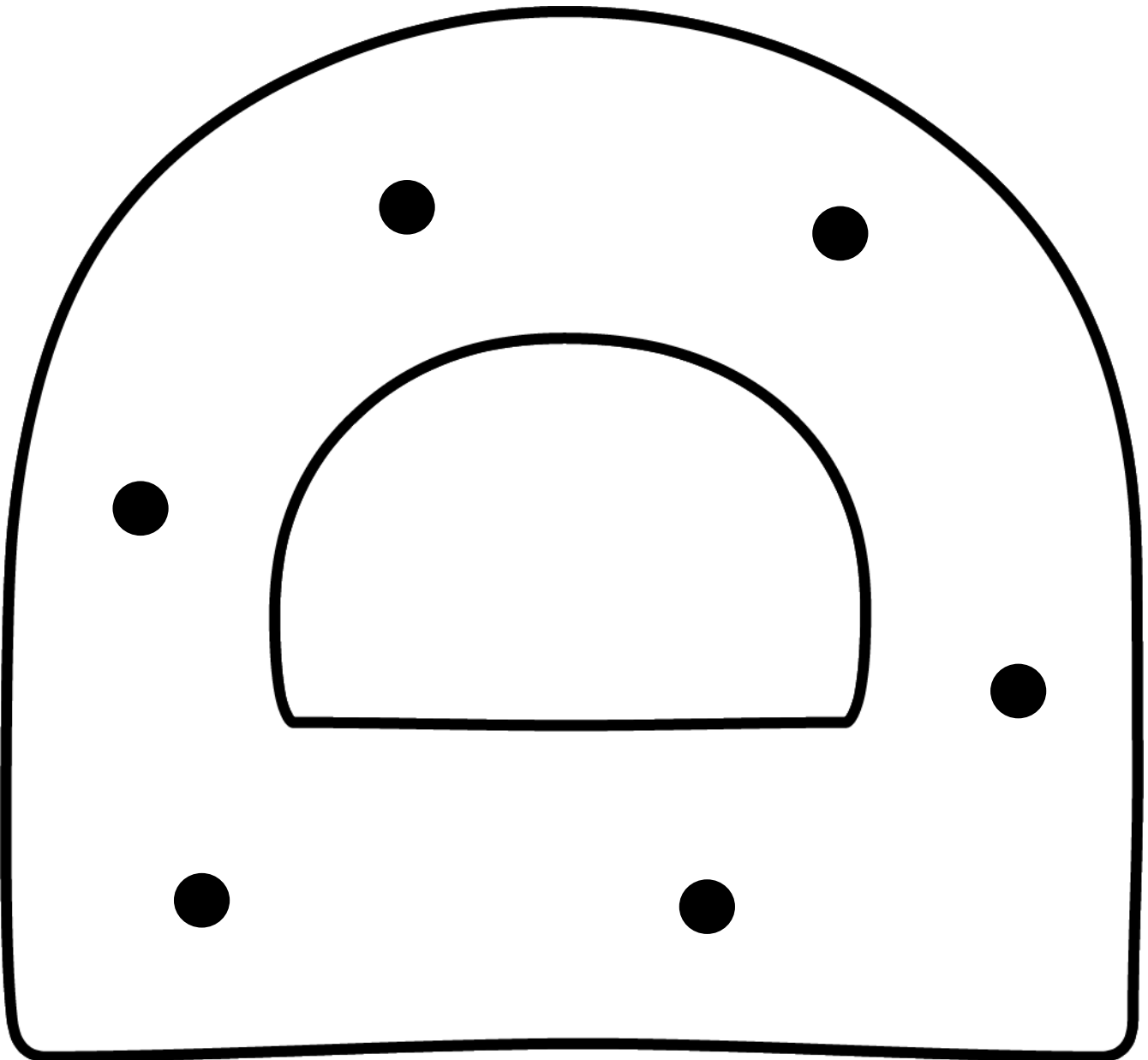
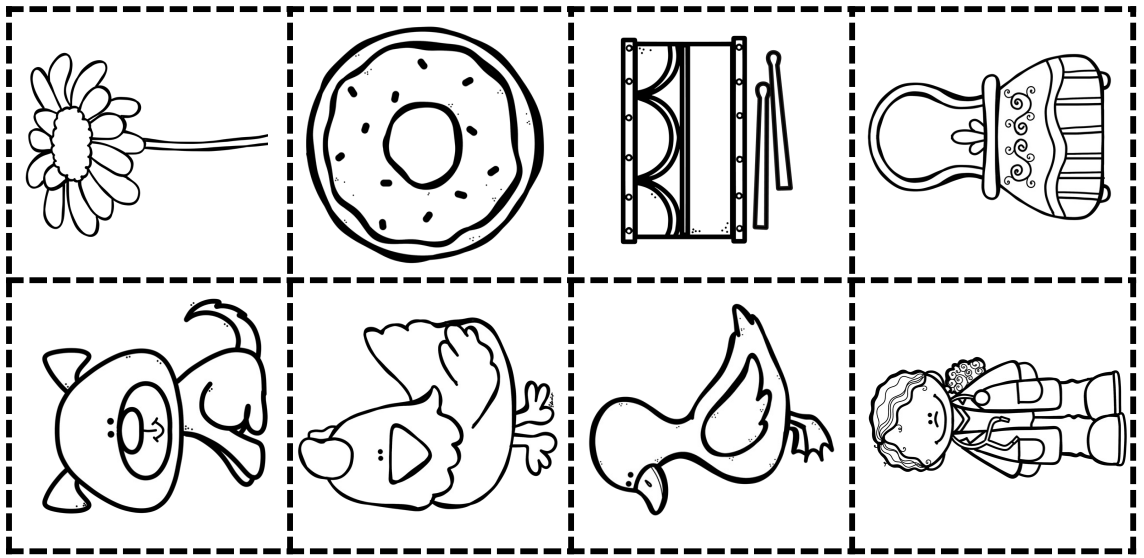

Name _____

Cut out and glue
the pictures
that
match the
letter.

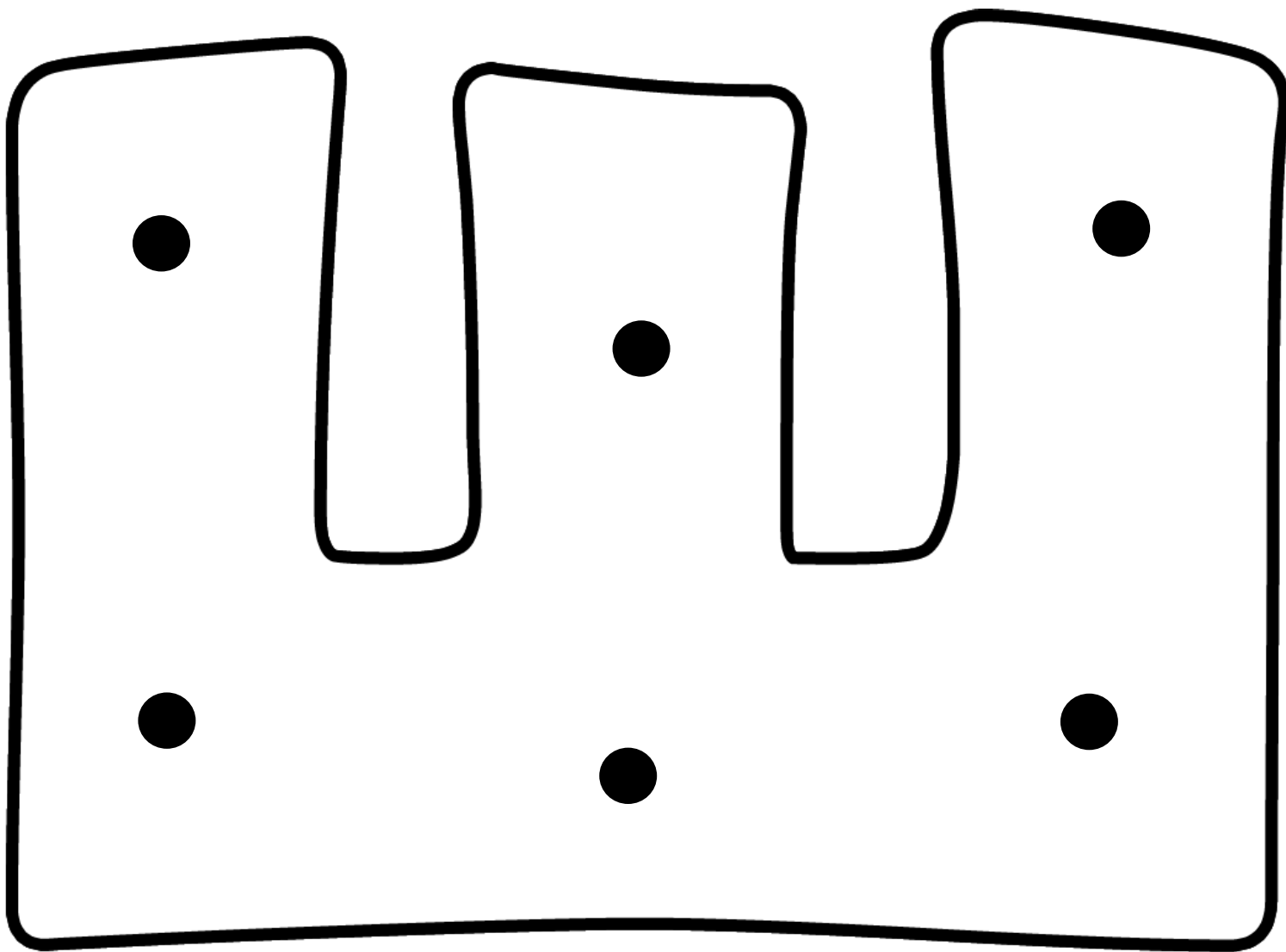
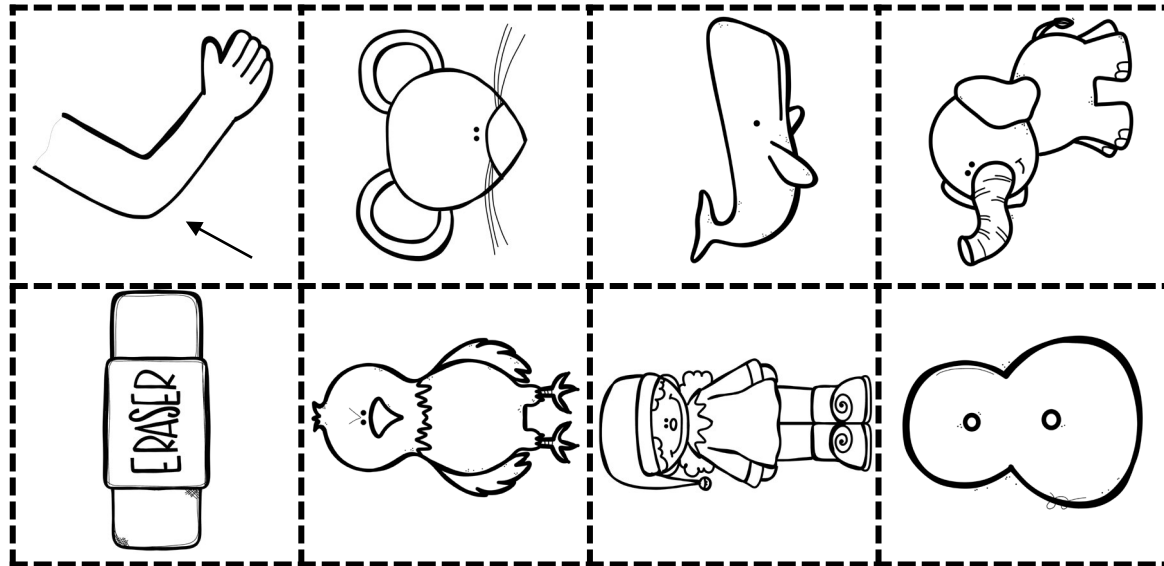

Name _____

Cut out and glue
the pictures
that
match the
letter.

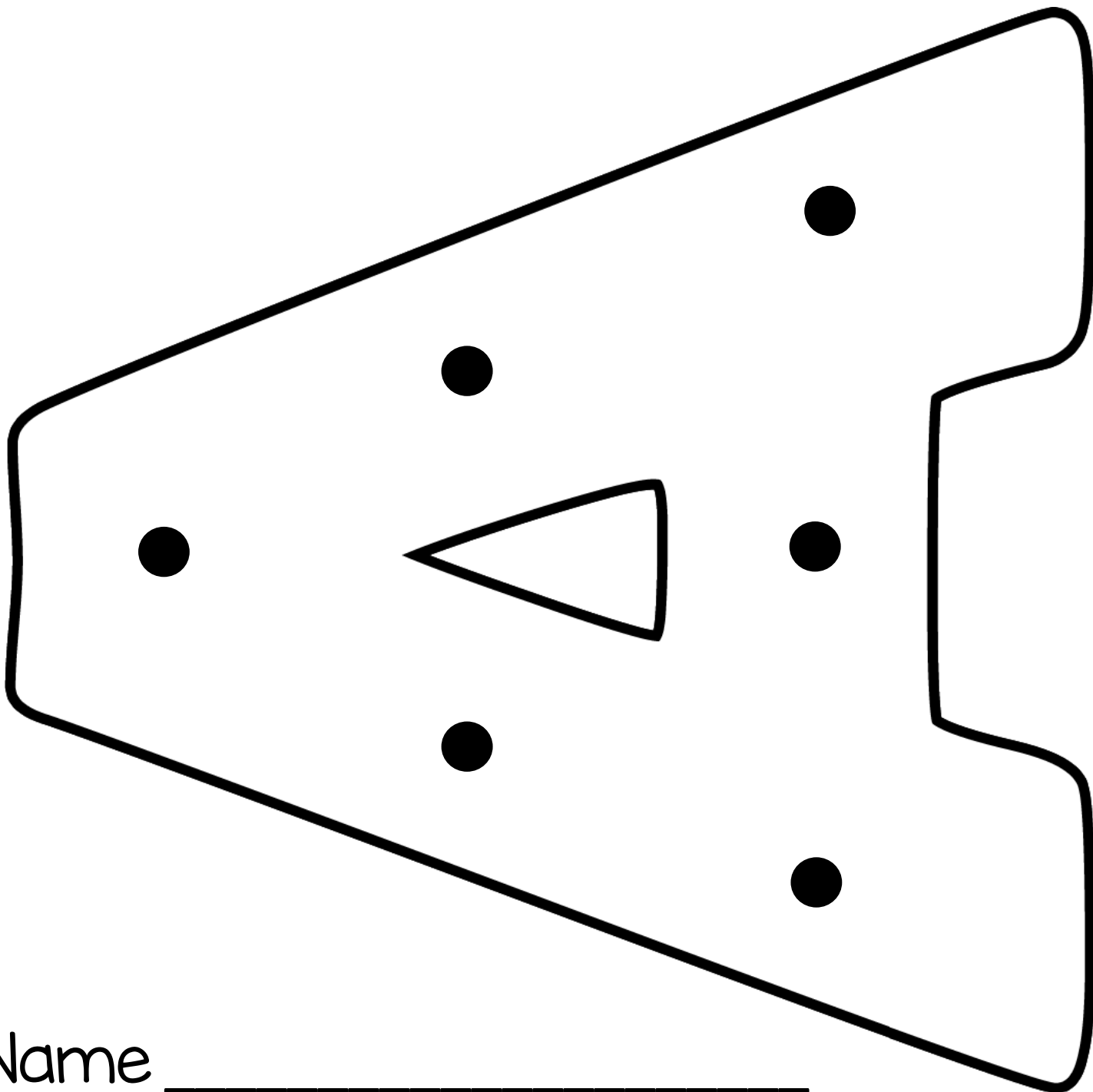
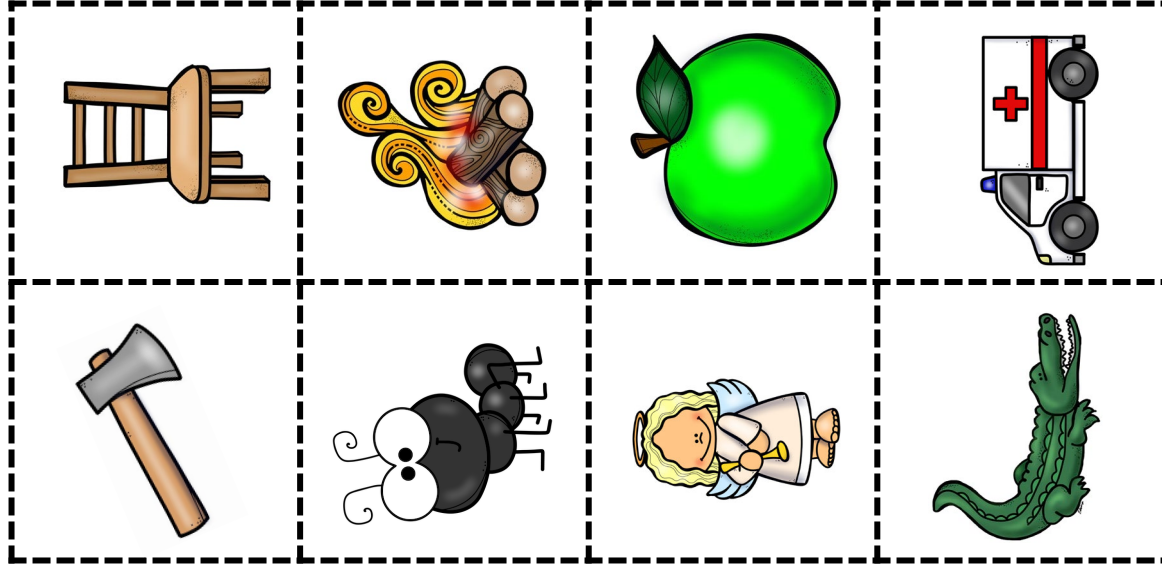

Name _____

Cut out and glue
the pictures
that
match the
letter.

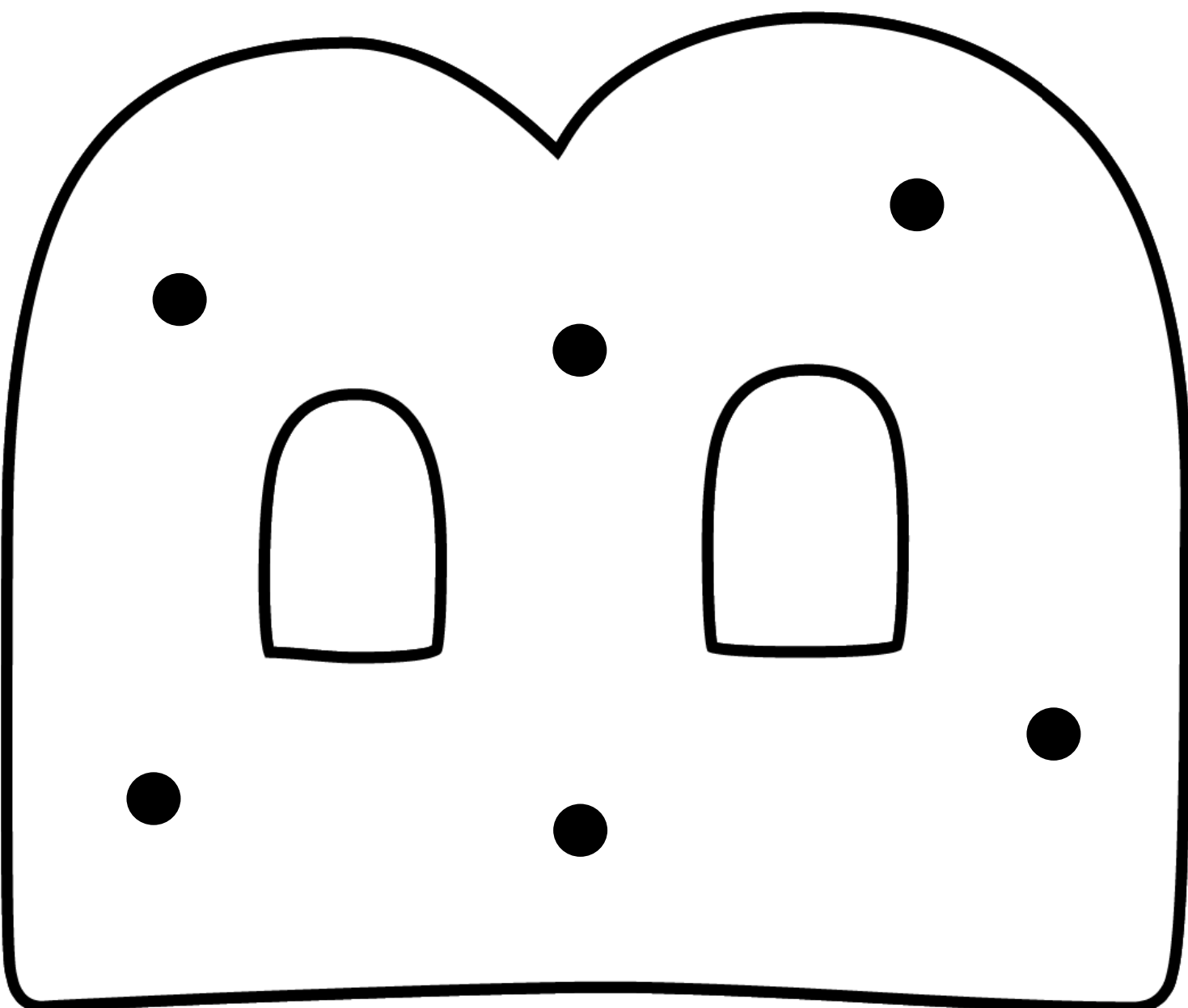
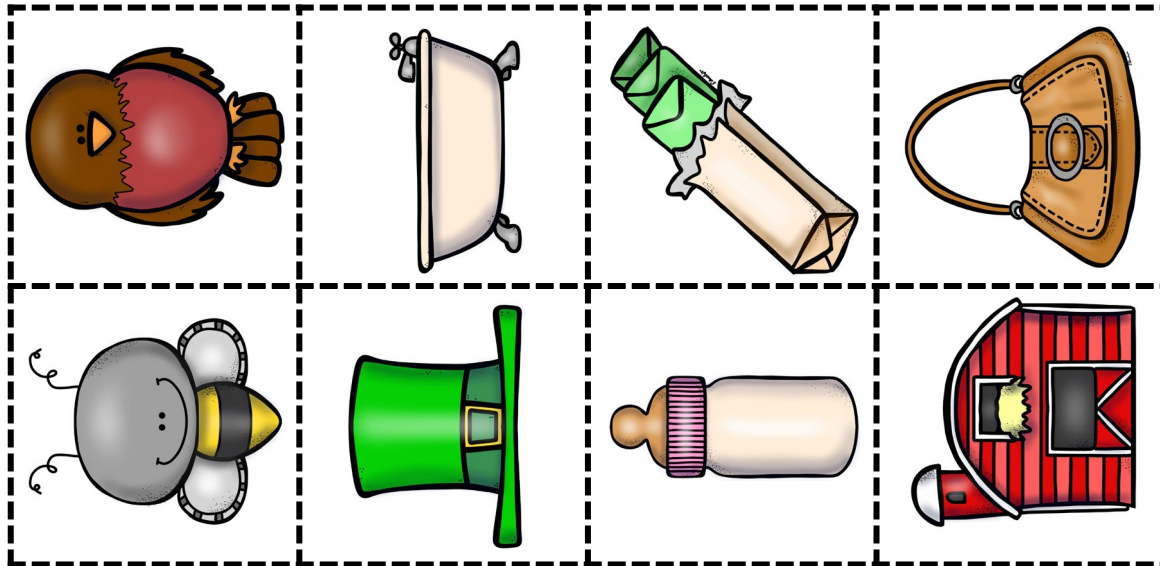

Name _____

Cut out and glue
the pictures
that
match the
letter.

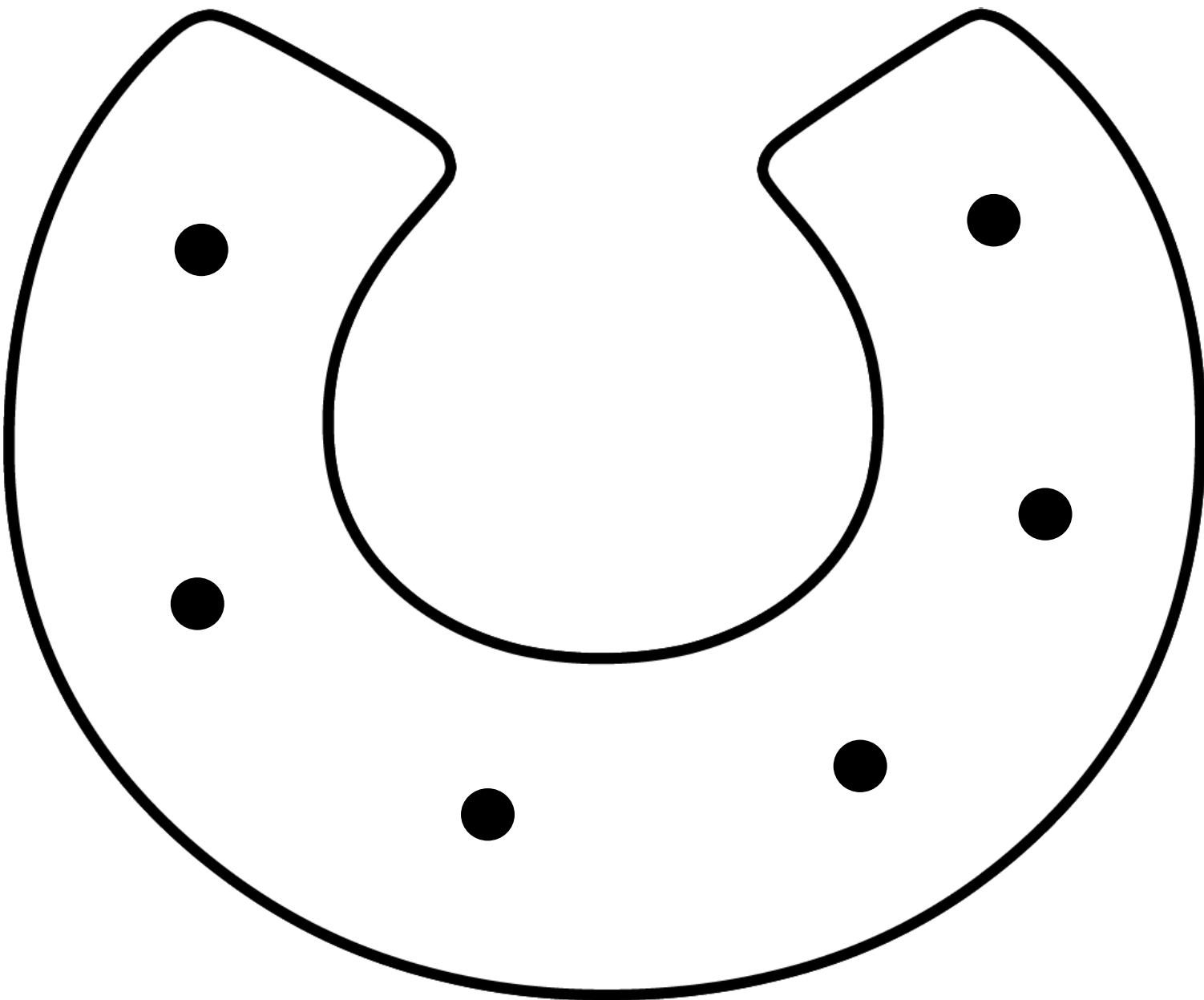
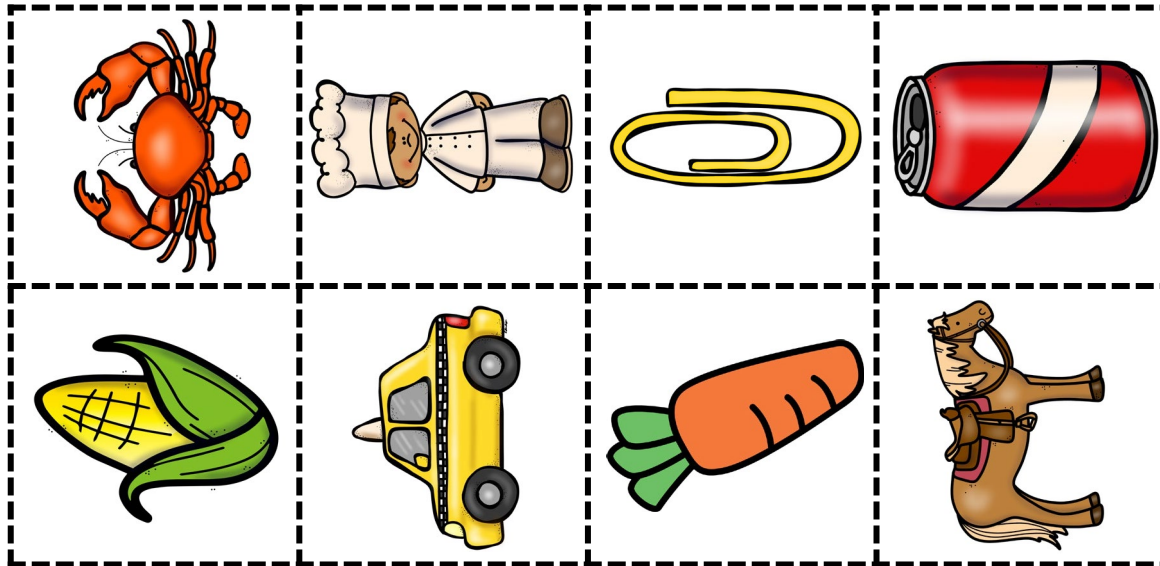

Name _____

Cut out and glue
the pictures
that
match the
letter.

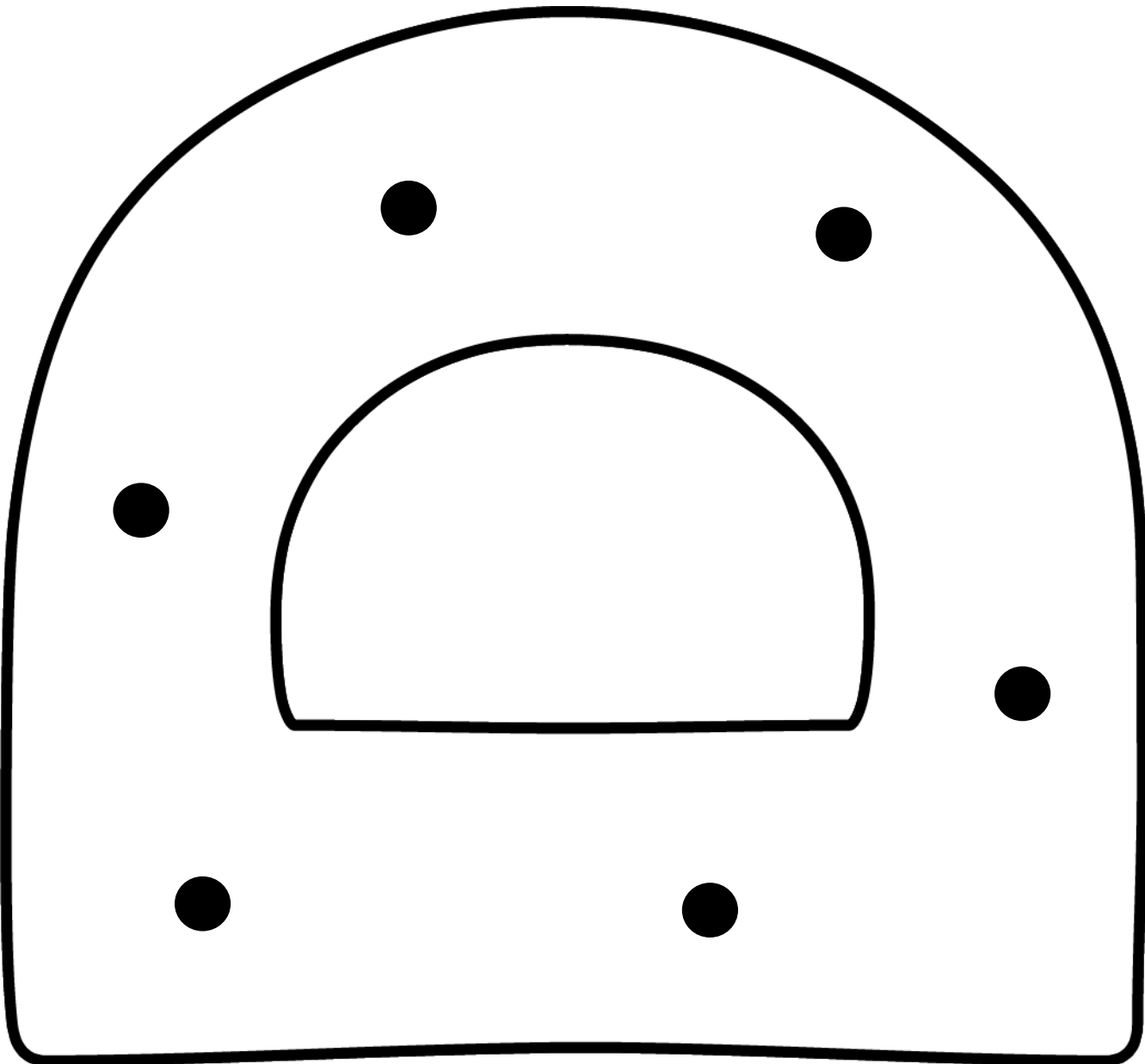
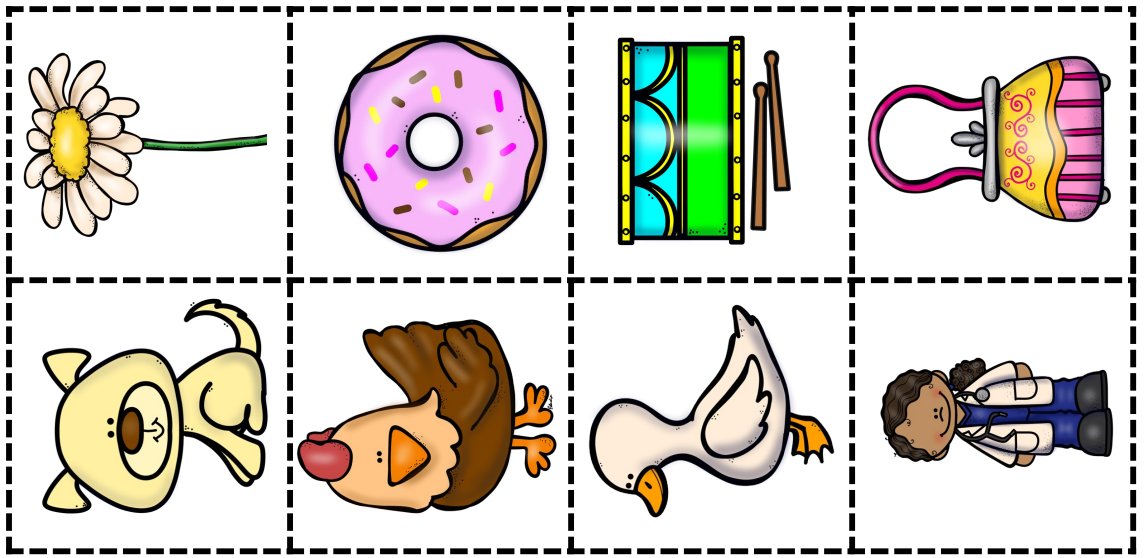

Name _____

Cut out and glue
the pictures
that
match the
letter.

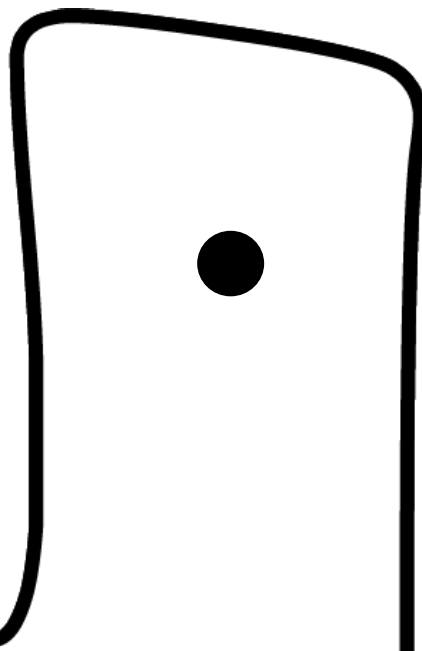
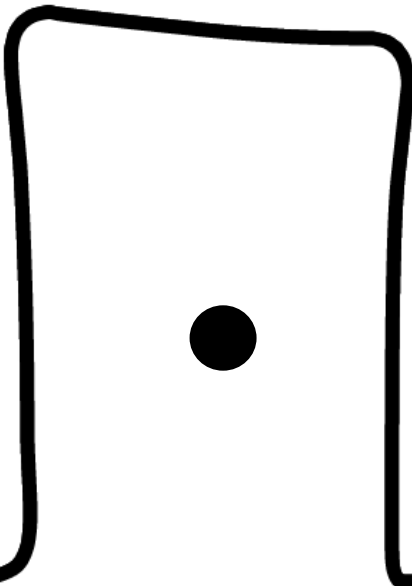
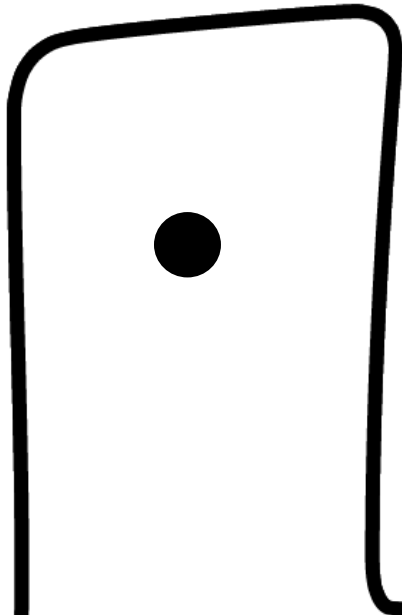
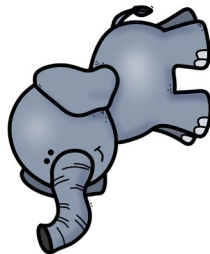
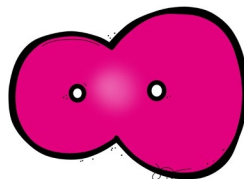
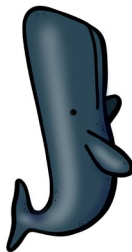
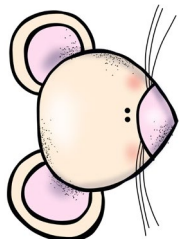
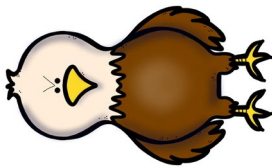
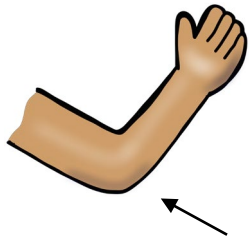
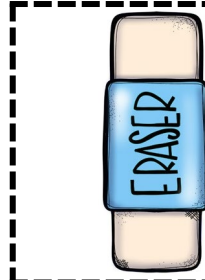

Name _____